



STOP! PLEASE READ FIRST

Inverted Frame No. R4825 (Black)

ASSEMBLING YOUR 48.5" (8-sided) DOME FRAME: (Allow 15 to 20 minutes)

Tools Required: Screwdriver & Wrench (Socket or Small Adjustable)

- 1) Remove all contents from container. You should have these parts:
- | | |
|---------------------------------------|--------------------------------------|
| 8 Inverted Dome Arms | 8 Angled Top Ceiling Plates |
| 1 Center (Bottom) Ring | 9 #12-24 x 5/8" Bolts & Flat Nuts |
| 1 Instruction Set [& Patterns on web] | 17 Silver #12-24 x 3/8" Bolts & Nuts |
| 4 1/4" x 2" mounting lag screws | 30" Foam (Self-Adhesive) Tape |
- And, for Wood Moulding Trim Kit:
- | | |
|-------------------------------------|------------------------------------|
| 8 Poplar precut crown moulding pcs. | 17 #6 x 3/4" Screws for trim mount |
|-------------------------------------|------------------------------------|

- 2) On a FLAT surface (a 4' x 4' area is needed), lay out the Center Ring, and the eight Arms radiating from the Center Ring. Face the side of the arm with just one hole in the tongue towards the Center Ring.

(Figure 1) You will be assembling the frame upside down from the way it will be installed on the ceiling---the "Center Bottom Ring" will be temporarily on top.

- 3) Start connecting the Arm tongues to the Center Ring using the SMALLER nuts & bolts: The Arm tongues are designed to fit BELOW the Bottom Ring (as viewing the dome concave downward--the opposite from how it hangs when installed.) **(Figure 2)** The bolts should be applied from the top first through the Center Ring, and then through the Arm's tongues, with the nuts below the tongues. APPLY the NUTS LOOSELY at this point--DO NOT TIGHTEN. Stagger the first three arms to make the frame sit level. **(Figure 3)** This makes it easier to attach the remaining arms.

- 4) Next, arrange the Angled Top Ceiling Plates around the base of the dome. The side with three holes should rest flat on the level surface. The other side (with 4 holes, and corner cutouts) should be standing upright, and facing nearest the center of the frame. The brackets on the Arms are designed to be attached on the OUTSIDE of the Angled Top Ceiling Plates (i.e. to the vertical side of the Angled Top Ceiling Plate that faces AWAY from the dome's center). **(Figure 4)** Hence, they will be visible when the frame is installed on the ceiling before the wood trim covers them.

Connect the Arm brackets to the Angled Top Ceiling Plates using the 3/18" nuts & bolts, applying the bolts FROM the INSIDE of the dome frame. **(Figure 4)** Again, APPLY the NUTS LOOSELY--DO NOT TIGHTEN. The frame is precision-designed so that the parts fit together snugly without the need for forcing. If the nuts do not enter the holes easily, check to be sure that the brackets are on the correct side of the Angled Ceiling Plates, and that the Dome Arms were all installed on the bottom side of the upside down Center Ring.

- 5) Align the Dome Arms before beginning to tighten the nuts with the wrench and screwdriver. The Dome Arms opposite each other should be in a **straight line**. First, tighten all the nuts at the Angled Ceiling Plates after checking that the arms are setting evenly and not cocked to one side. Second, tighten ONE nut on the Center Ring. [Note: Be sure that you slide the arms at the center ring all the way toward the center of the ring before tightening the nuts. (The tongue has a slotted hole for easy assembly.)] Check alignment again before tightening the opposite nut on the Center Ring. Tighten the remaining nuts. **(Tighten the nuts firmly, but not so hard that you strip the threads!)** Apply 8 short pieces (cut to 3.5" ea.) of insulating foam to the center ring (3/8" from outside edge of ring between each tongue) to seal off light once glass panels are set in frame. You might want to check your assembly by testing fit of glass panels before mounting frame. **(See Figure 5b)**

48.5" (8-sided)

Note: These illustrations are for the 8-sided 48.5" inverted dome frame.

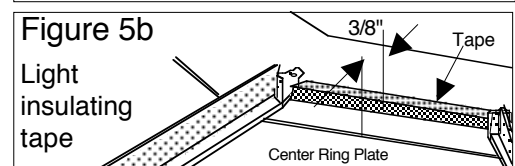
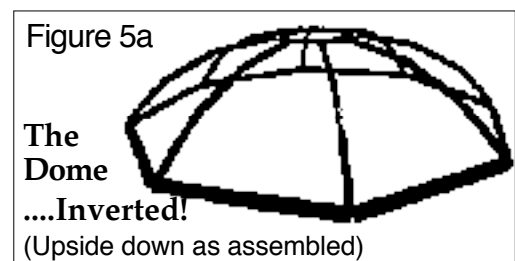
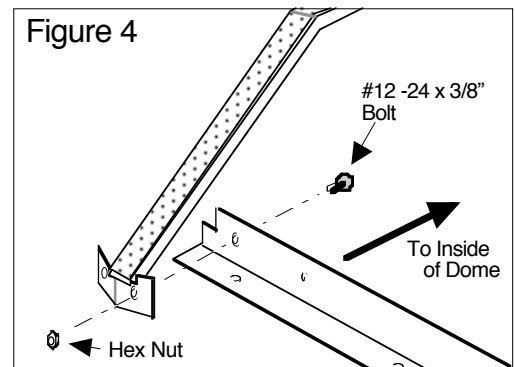
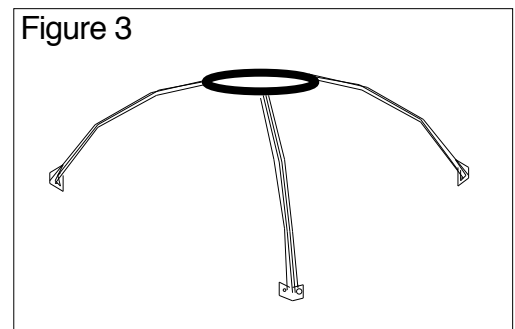
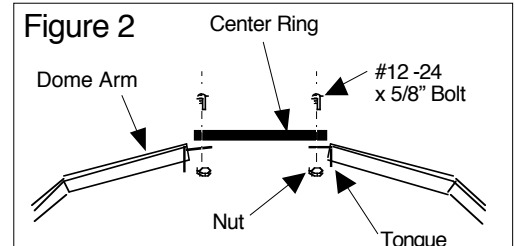
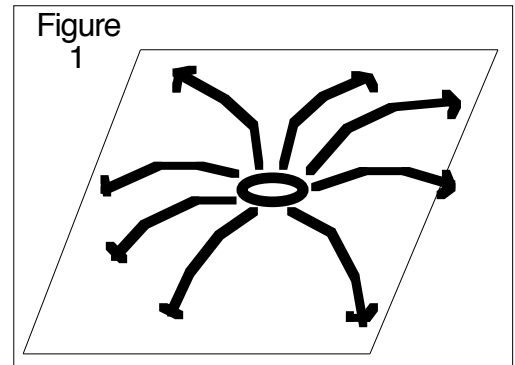

GENERAL INFORMATION FOR INSTALLATIONS (48.5" 8-sided inverted dome frame)

APPLICATIONS: (See Figures 6 & 7)

- **BACK LIGHTING WITH ARTIFICIAL LIGHT:** Inverted dome is installed on a flat ceiling under a standard ceiling light fixture.
- **BACK LIGHTING WITH SKYLIGHT:** Inverted dome is installed on flat ceiling under **SEALED** sheetrock shafting to a roof mounted skylight (any size). Inverted dome fits easily under a standard 4' square bubble skylight in flat roofs. Artificial lights, located within easy reach from below dome, should be added to the sealed shaft for night lighting. Skylights with white bubbles are recommended to avoid "hot" spots on glass panels.
- **ADDING AUXILIARY LIGHTING TO DOME FRAME:** Special center ring plates can be ordered with holes for attaching a flush mount ceiling fan, -or-, mounting a recessed light fixture above the center ring (either Juno® 4" or 6" can downlight fixtures.)

INSTALLATION GUIDELINES

- **NEW CONSTRUCTION:** A square is framed with standard joists on 48" centers. The Dome....Inverted! is bolted to these joists. Wiring for two circuits should be provided—one with on/off switch for fluorescent lighting, and other with dimmer switch for incandescents. A third is needed if auxiliary lighting or ceiling fan is attached to the frame
- **RETROFITTING TO EXISTING STRUCTURES:** Because The Dome....Inverted! is merely bolted to the ceiling, retrofitting is relatively easy, provided the frame can be bolted into the ceiling joists or trusses on at least two opposite sides to safely carry the weight of the frame and glass (50 - 60 lbs.). (If a ceiling fan is attached to the frame, the frame must be bolted in 4 alternating ceiling plates, and Lock-Tite® should be applied to the threads of the screws when assembling the frame to safely accommodate any vibration caused by the fan.)

If ceiling joists or trusses aren't conveniently located for support of desired frame location, merely add 2x4 cross members such that they span the center of four alternating ceiling plates so you can use wood screws to mount the frame to ceiling. (See Fig. 8) If needed, you can also drill extra holes in two of the ceiling plates.

Use at least a #14x2-1/4" flat or pan head wood screw in at least two opposing ceiling plates, being sure the screw is biting at least 1.38" into the wood joist for proper support. The other two sides can be held with ceiling toggle (anchor) bolts (30 lb. min. rating) if the ceiling is standard 5/8" or thicker sheetrock. (Four 1/4" x 2" lag screws provided.)

- **INSTALLING THE WOOD TRIM:** Before installing glass panels, install the wood trim as follows. Mount one of the trim pieces as shown in Fig. 9, and attached very loosely using two #6 screws (provided) through the two small holes in the ceiling plate. (You may need to adjust the positioning if you didn't precisely center the trim piece.) Repeat for the remaining trim pieces. **DO NOT TIGHTEN UNTIL YOU HAVE INSTALLED AND ALIGNED ALL 8 TRIM PIECES.** The trim can be painted before installing.

CAUTION ! IF A SKYLIGHT SHAFT IS ABOVE INVERTED DOME, THE SHEET-ROCKED SHAFT TO SKYLIGHT MUST BE TIGHTLY AND PROPERLY SEALED AND NOT VENTED TO ATTIC NOR EXTERIOR FOR MEETING BUILDING CODES & SAFETY REQUIREMENTS. Failure to observe this can result in glass panels lifting out of the frame and falling! For example, on a windy day when a window or door is opened to the wind, the air pressure can blow or suck out the glass panels if the area above the dome has any exposure to the building's exterior. (Remember, the glass panels are held in place by gravity so they can be easily removed from below for cleaning or changing light bulbs.) Also, leaded glass does not qualify as a fire break to prevent the spread of fire to the attic or other areas above the dome. **IF LIGHT OR FAN IS ATTACHED TO DOME FRAME, THE FRAME SHOULD BE PROPERLY ELECTRICALLY GROUNDING.**

INSTALLATION OF THE GLASS PANELS (Install from underside of dome frame):

First install the panel that fits into the center ring (if applicable).

Next, for each section, install first the bottom (smallest) panel, being certain that the perimeter zinc or brass came at the base rests against the lip of the tongues. **Check your positioning of the foam so all light below the first glass panel is sealed off.** Then install the 2nd tier, being certain to interlock the first & second panels' H-channels. Continue up the section until the top tier (largest) is installed, again being certain that its base H-channel interlocks into the panel below. The top of the final tier rests against the angled ceiling plate. (You may have to tap gently the top of panel #2 temporarily in order to tuck in #3 under bolts.)

TO REMOVE THE GLASS PANELS (from underside of dome frame):

If the glass panels need to be removed at a later time for cleaning or changing of light bulbs, **ALWAYS FIRST REMOVE THE TOP TIER (LARGEST PANEL), AND PROCEED DOWN THE TIERS IN EACH SECTION.**

CAUTION: REMOVAL OF THE BOTTOM PANEL FIRST COULD CAUSE THE UPPER PANELS TO SLIDE DOWN AND FALL OUT!

DISCLAIMER: Selection of Sierra Stained Glass products to conform to all local applicable laws, ordinances, building codes, and safety requirements is the sole responsibility of the architect, house/building owner and/or contractor. Proper installation of our products is the responsibility of the customer. Sierra Stained Glass Studios has no responsibility in these regards.

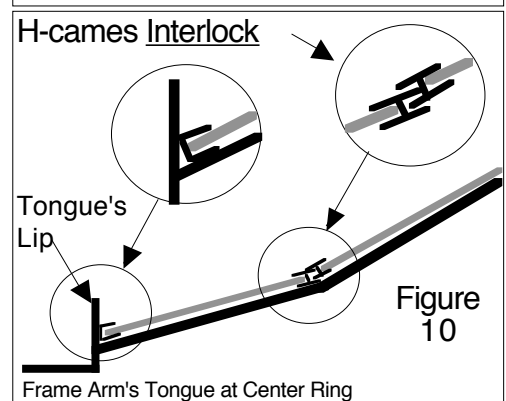
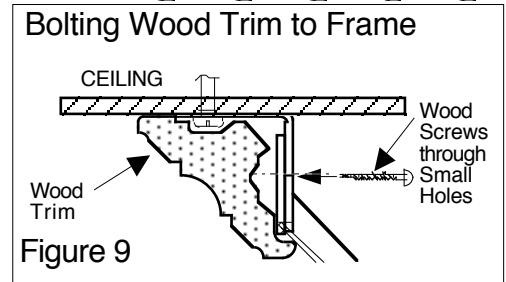
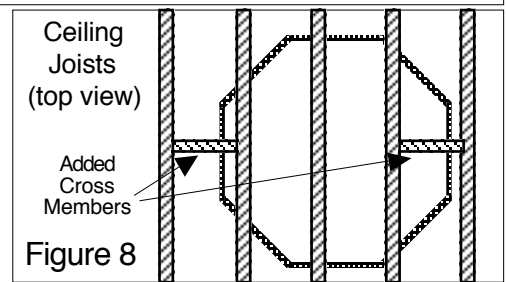
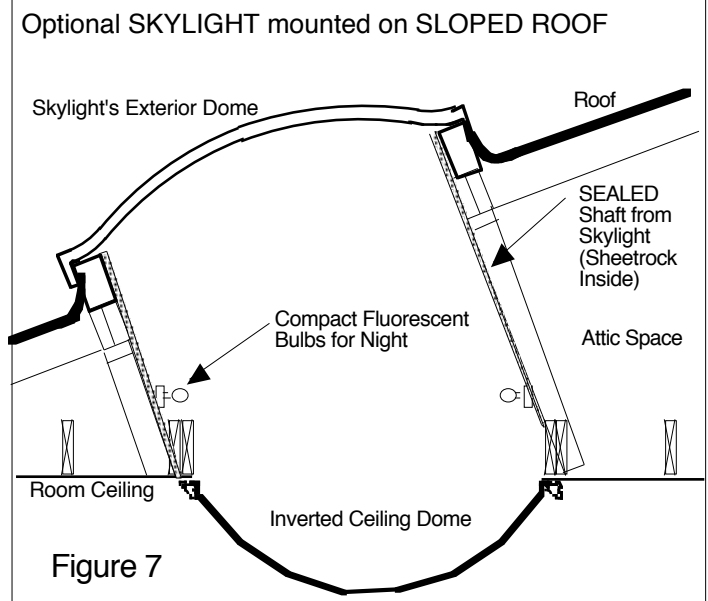
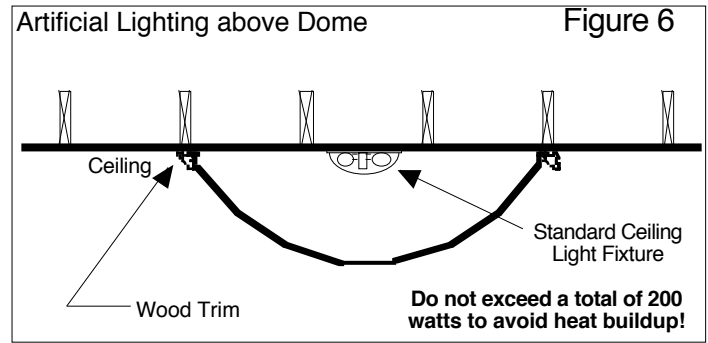

Standard Designs

(available as free downloads in PDF format)

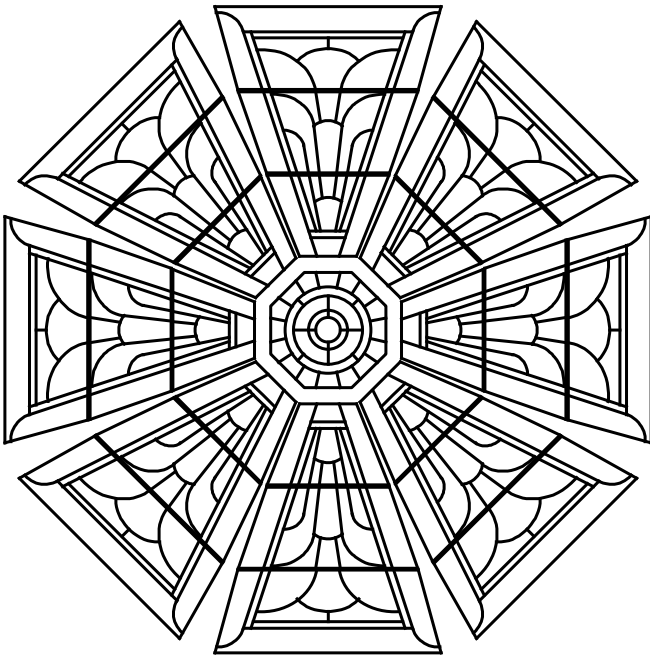

Cascade

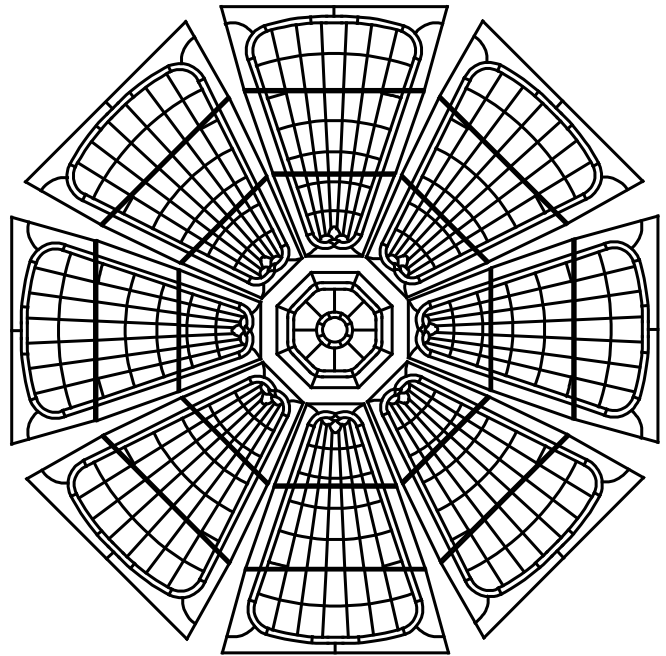

De'noument

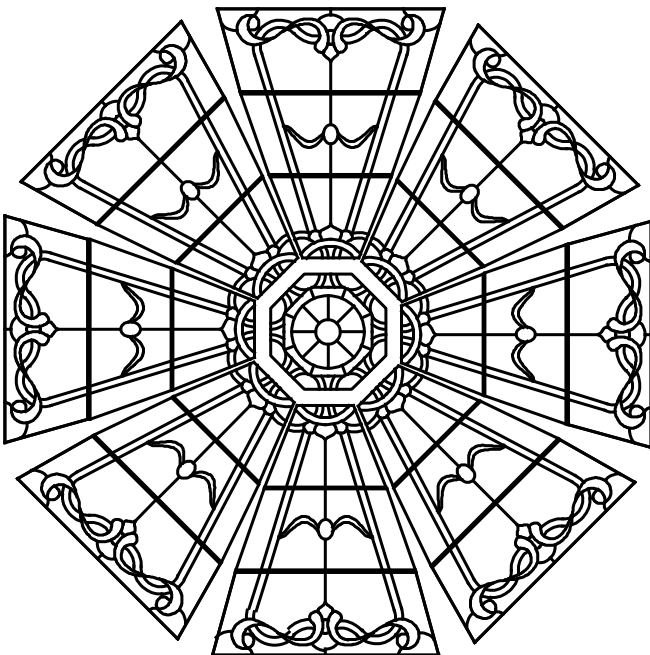

Nouveau

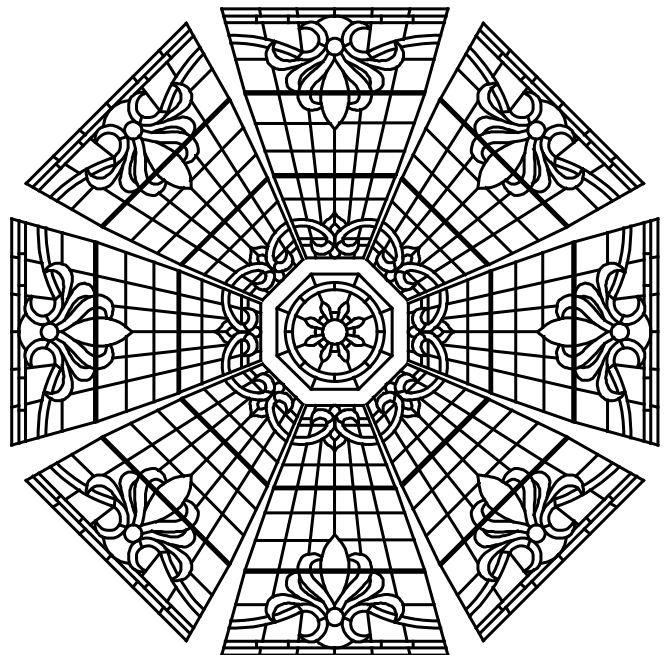

Victorian

The Dome...Inverted!

A Convex Lighting Fixture 48.5" x 12"

Sierra Stained Glass Studios 1153 Yale Ave Modesto, CA 95350